

OREGON RULE CO.
SINCE 1981

FORENSICS PRODUCTS

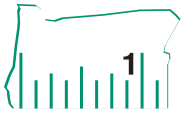

We Measure Up, Down, Sideways and in Circles!



Oregon Rule Co.
1610 S Red Soils Ct Ste C
Oregon City, Oregon 97045

Copyright © 2019 by Oregon Rule Co.

This catalog is designed to help Oregon Rule Co. customers discover measuring tools that are intended to increase accuracy, expand tool sets, and most importantly - save time.

Listed descriptions are meant to be straight-forward, and should provide all necessary information to ensure the correct product or tool is being purchased.

This publication mostly translates with our website, where you may place orders or gain access to more photos of our products. Products listed in previous catalogs may have become unavailable or obsolete, depending on the availability of materials and/or consumer demand.

Additionally, items in this catalog may be added or removed at any time at Oregon Rule's discretion.

All rights reserved, including the right to reproduce this catalog or portions thereof in any form whatsoever.

Manufactured in the United States of America.



For information on the most up-to-date product availability, please visit our website at www.oregonrule.com or www.orcforensics.com

Quote requests may be sent to sales@oregonrule.com

Custom Options (Call 503.657.8330 for quote):
i.e. Sizes, Colors, Private Labeling, etc.

Table of Contents

Rules

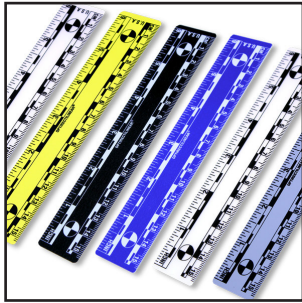

1-3

Corner Squares

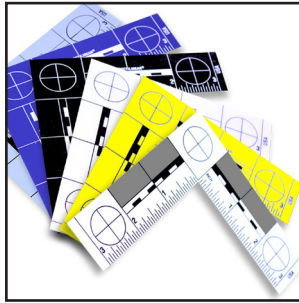

4-6

Extra Large Folding Rules

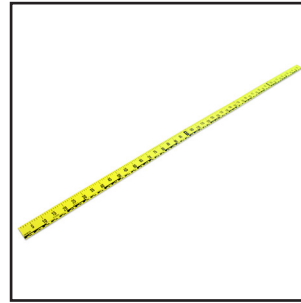

7

Footprint & Tire Tracks



8-10

Large Graduated Angles and Rules

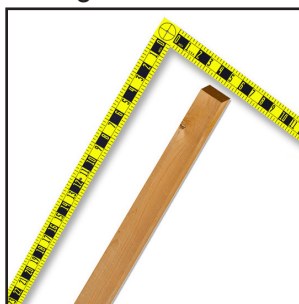

11-12

MPF Stringer Rules



13

I.D. Labels

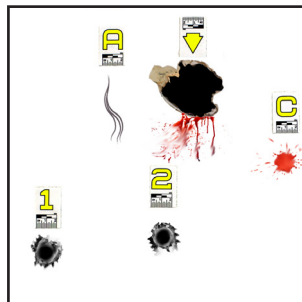

14

Adhesive Ruler Decals



15-19

Adhesive Corner Square Decals

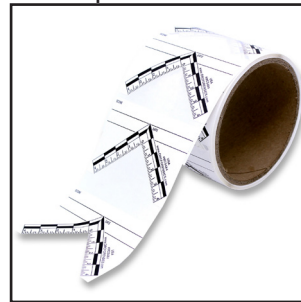

20

Roll Tapes

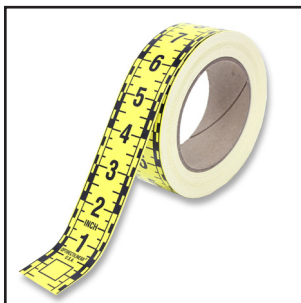

21-22

Hand Tools

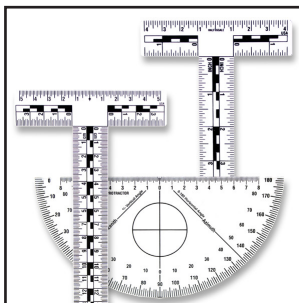

23

Cards and Charts

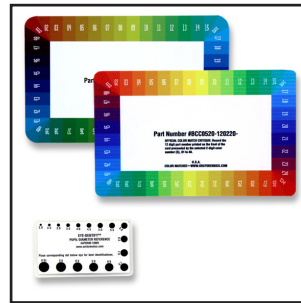

24-25

Oregon Rule Co. Forensics Products specialize in a vast line of superior forensics rules and frame-of-reference devices. Our rules feature technical specifications that are intended to speed up work-flow without compromising accurate measurements.

Rules in this section come in two standard sizes, and a selection of different colors. The reading style for a single rule is both Fractional (inches) and Metric (centimeters), oriented left to right. The 2"/5cm rules are 1" wide, while 6"/15cm rules are 1 3/16" wide.

Adhesive-Backed rules are sold in sets of 25. Plastic rules are sold in sets of 10. Magnetic sets of 5.

One technical specification of the rules in this category is our unique Optirectilinear® graphic. The Optirectilinear® graphic is the multiple rectangle configuration between the Fractional and Metric readings. These graphics extend the visible range of the increments and help clarify readings taken from photographs.

Black

Fractional & Metric		
Part #	Material	Length x Width
4RFM-BK002PP/AB/25pk	Adhesive-Backed	2in / 5cm
4RFM-BK002PL/10PK	Plastic	2in / 5cm

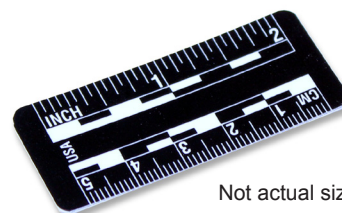

Not actual size

Blue

Fractional & Metric		
Part #	Material	Length x Width
4RFM-BL002PP/AB/25pk	Adhesive-Backed	2in / 5cm
4RFM-BL002PL/10PK	Plastic	2in / 5cm

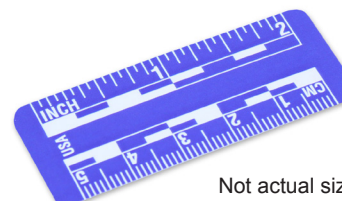

Not actual size

Gray

Fractional & Metric		
Part #	Material	Length x Width
4RFM-GY002PP/AB/25pk	Adhesive-Backed	2in / 5cm
4RFM-GY002PL/10PK	Plastic	2in / 5cm

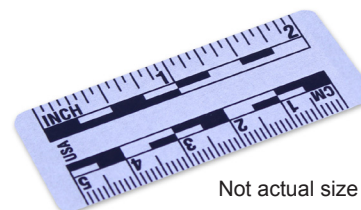

Not actual size

White

Fractional & Metric		
Part #	Material	Length x Width
4RFM-WH002PP/AB/25pk	Adhesive-Backed	2in / 5cm
4RFM-WH002PL/10PK	Plastic	2in / 5cm



Not actual size

Yellow

Fractional & Metric		
Part #	Material	Length x Width
4RFM-YW002PP/AB/25pk	Adhesive-Backed	2in / 5cm
4RFM-YW002PL/10PK	Plastic	2in / 5cm

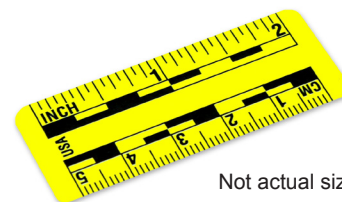

Not actual size

Black

Fractional & Metric		
Part #	Material	Length
4RFM-BK006PP/AB/25pk	Adhesive-Backed	6 in / 15cm
4RFM-BK006PL/10PK	Plastic	6 in / 15cm
4RFM-BK006MG/5pk	Magnetic	6 in / 15cm

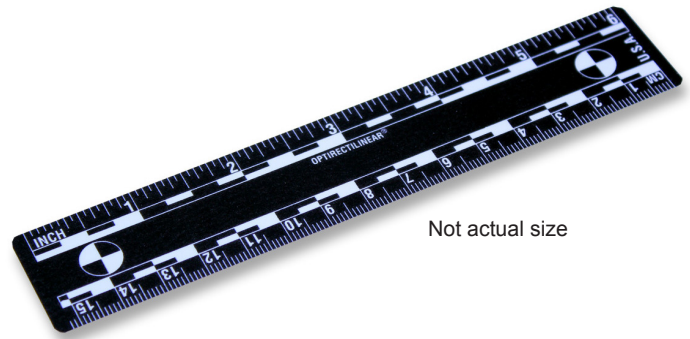

Blue

Fractional & Metric		
Part #	Material	Length
4RFM-BL006PP/AB/25pk	Adhesive-Backed	6 in / 15cm
4RFM-BL006PL/10PK	Plastic	6 in / 15cm

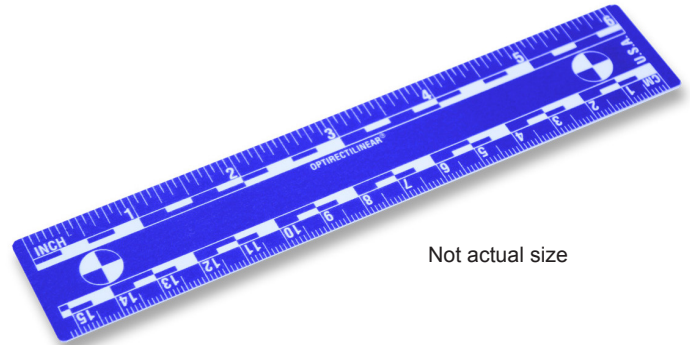

Gray

Fractional & Metric		
Part #	Material	Length
4RFM-GY006PP/AB/25pk	Adhesive-Backed	6 in / 15cm
4RFM-GY006PL/10PK	Plastic	6 in / 15cm

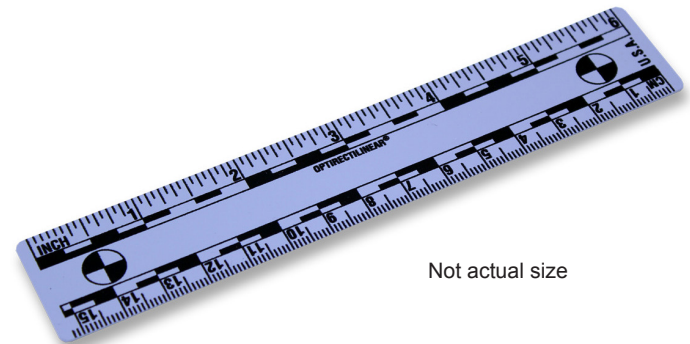

White

Fractional & Metric		
Part #	Material	Length x Width
4RFM-WH006PP/AB/25pk	Adhesive-Backed	6 in / 15cm
4RFM-WH006PL/10PK	Plastic	6 in / 15cm
4RFM-WH006MG/5pk	Magnetic	6 in / 15cm

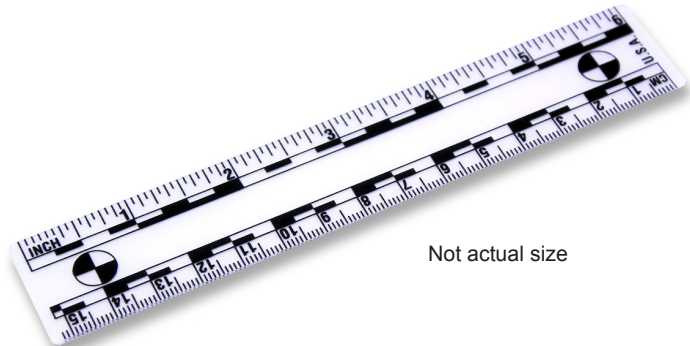

Yellow

Fractional & Metric		
Part #	Material	Length
4RFM-YW006PP/AB/25pk	Adhesive-Backed	6 in / 15cm
4RFM-YW006PL/10PK	Plastic	6 in / 15cm

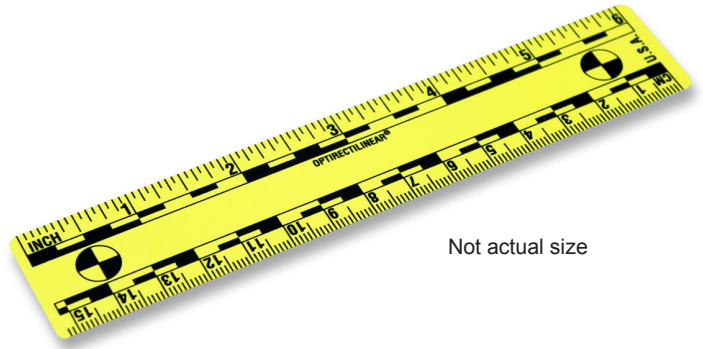

Not actual size

Clear

Fractional & Metric		
Part #	Material	Length
4RFM-CL006PP/AB/25pk	Adhesive-Backed	6 in / 15cm
4RFM-CL006PL/10PK	Plastic	6 in / 15cm

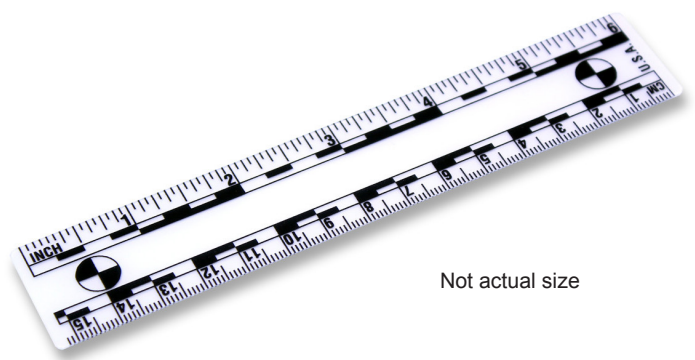

Not actual size



Oregon Rule Co. Forensics Products provides many varieties of corner squares, with options including length, color, and the material used. Each of the corner squares in this section measure approximately 4" x 4", with the measured reading range (at the inside edges) being 3" x 3". At ultra-competitive pricing, you will not find corner squares of this quality at our prices anywhere else.

Corner Squares

A special feature that all of the corner squares in this category share is our unique Optirectilinear® graphics. These are the black rectangles you see on many of our products. These graphics extend the visible range of the increments and help clarify reading taken from photographs.

Fractional

Black

Fractional		
Part #	Material	Length x Width
4CSF-BK3x3PP/AB/25pk	Adhesive-Backed	3in x 3in
4CSF-BK3x3PL	Plastic	3in x 3in
4CSF-BK3x3MG	Magnetic	3in x 3in

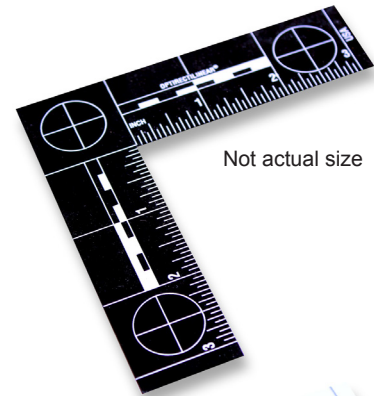

Not actual size

White*

Fractional		
Part #	Material	Length x Width
4CSF-WH3x3PP/PG/AB/25pk	Adhesive-Backed	3in x 3in
4CSF-WH3x3PL/PG	Plastic	3in x 3in
4CSF-WH3x3MG/PG	Magnetic	3in x 3in

*Also available in all white (no gray squares)

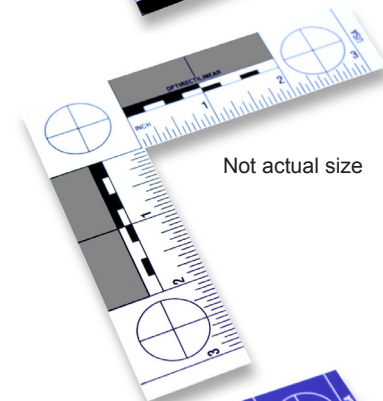

Not actual size

Blue

Fractional		
Part #	Material	Length x Width
4CSF-BL3x3PP/AB/25pk	Adhesive-Backed	3in x 3in
4CSF-BL3x3PL	Plastic	3in x 3in

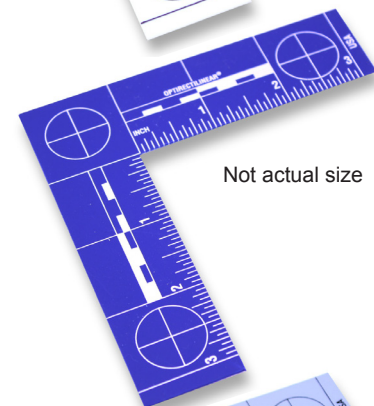

Not actual size

Gray

Fractional		
Part #	Material	Length x Width
4CSF-GY3x3PP/AB/25pk	Adhesive-Backed	3in x 3in
4CSF-GY3x3PL	Plastic	3in x 3in

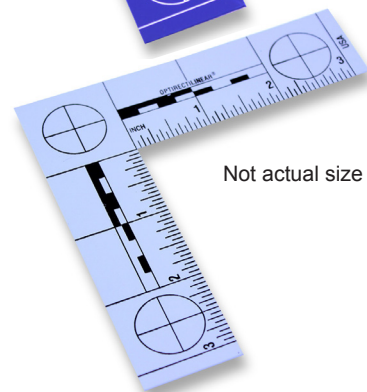

Not actual size

Clear**Fractional**

Part #	Material	Length x Width
4CSF-CL3x3PP/AB/25pk	Adhesive-Backed	3in x 3in
4CSF-CL3x3PL	Plastic	3in x 3in

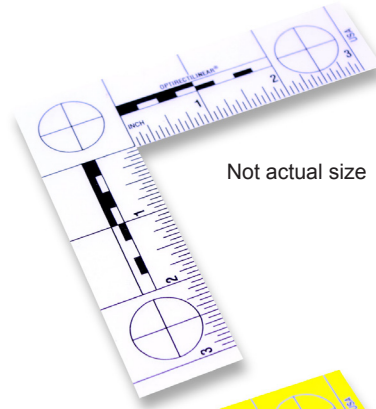

Not actual size

Yellow**Fractional**

Part #	Material	Length x Width
4CSF-YW3x3PP/AB/25pk	Adhesive-Backed	3in x 3in
4CSF-YW3x3PL	Plastic	3in x 3in

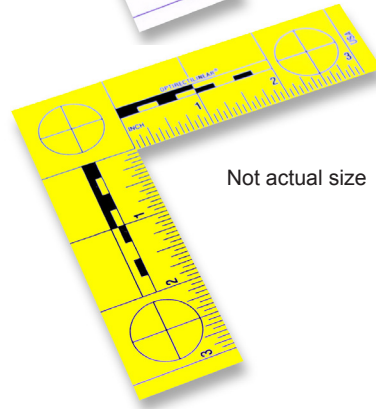

Not actual size

Metric**Black****Metric**

Part #	Material	Length x Width
4CSM-BK8x8PP/AB/25pk	Adhesive-Backed	3in x 3in
4CSM-BK8x8PL	Plastic	3in x 3in
4CSM-BK8x8MG	Magnetic	3in x 3in

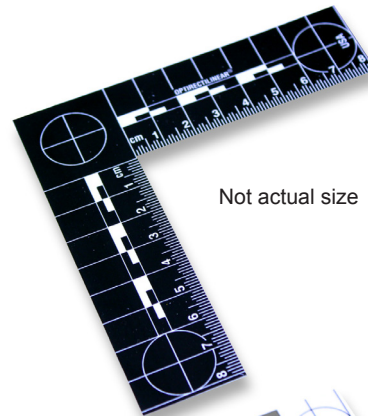

Not actual size

White***Metric**

Part #	Material	Length x Width
4CSM-WH8x8PP/PG/AB/25pk	Adhesive-Backed	3in x 3in
4CSM-WH8x8PL/PG	Plastic	3in x 3in
4CSM-WH8x8MG/PG	Magnetic	3in x 3in

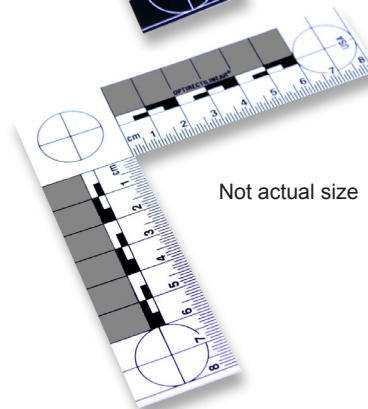

Not actual size

*Also available in all white (no gray squares)



Corner Squares

Blue

Metric		
Part #	Material	Length x Width
4CSM-BL8x8PP/AB/25pk	Adhesive-Backed	3in x 3in
4CSM-BL8x8PL	Plastic	3in x 3in
4CSM-BL8x8MG	Magnetic	3in x 3in

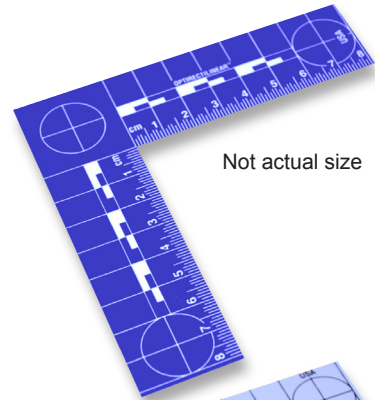

Not actual size

Gray

Metric		
Part #	Material	Length x Width
4CSM-GY8x8PP/AB/25pk	Adhesive-Backed	3in x 3in
4CSM-GY8x8PL	Plastic	3in x 3in
4CSM-GY8x8MG	Magnetic	3in x 3in

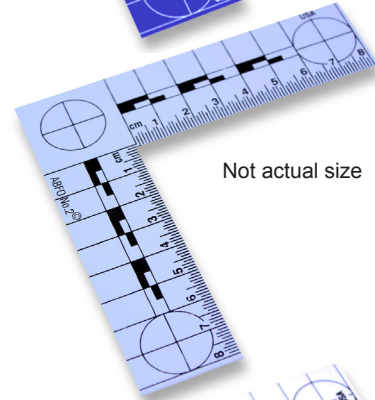

Not actual size

Clear

Metric		
Part #	Material	Length x Width
4CSM-CL8x8PP/AB/25pk	Adhesive-Backed	3in x 3in
4CSM-CL8x8PL	Plastic	3in x 3in

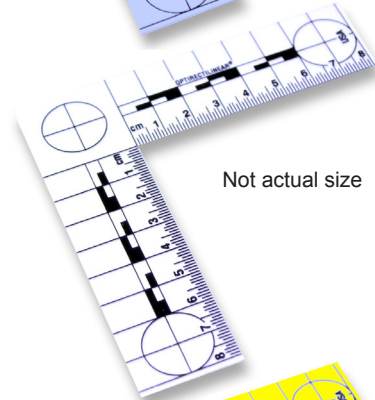

Not actual size

Yellow

Metric		
Part #	Material	Length x Width
4CSM-YW8x8PP/AB/25pk	Adhesive-Backed	3in x 3in
4CSM-YW8x8PL	Plastic	3in x 3in
4CSM-YW8x8MG	Magnetic	3in x 3in

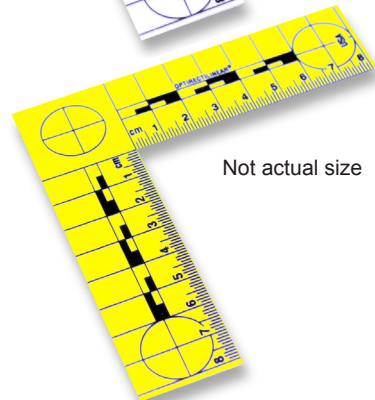

Not actual size

Special

ABFO

Metric		
Part #	Material	Length x Width
4CSM-WH5x5PL/ORIG	Plastic	3in x 3in

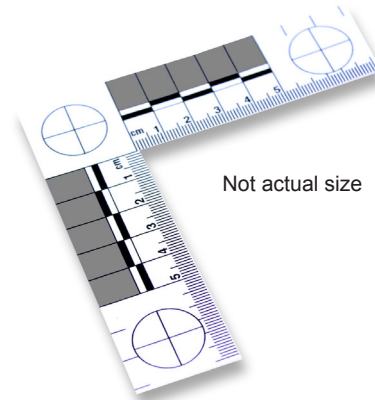

Not actual size



Extra Large Folding Rules

ORC Forensics' Extra Large Folding Rulers combine many of the features of our other large reference rulers into one useful package. Characteristics like having easy-to-read graphics, being built of weatherproof materials, and the ability to fold into a compact shape for portability are just a few of its advantages. **The Extra Large Folding Rules feature both Fractional and Metric reading styles on opposite sides of the same unit.** Sometimes referred to as a "body rule", for obvious reasons, this rule is also great at many other large frame-of-reference applications.

XL Folding Rules

Our own Optirectilinear® graphics are used on each side of the rule, which allows you to read measurements up to 40 feet away, and the bold yellow and black color scheme is designed for optimum clarity in photographs. Rulers are 2 1/2" wide and pivot out into 22 1/2" (57cm) sections. The fractional side has 1/4" graduations with inch and feet labels, and reads up to 102". The metric side has centimeter graduations with labels every 5cm and on meters, and has a maximum length of 260cm.

102" or 260cm, Left to Right

Two-Sided Fractional & Metric		
Part #	Material	Length
4LFMR-YW102L-5PC	Plastic	102"

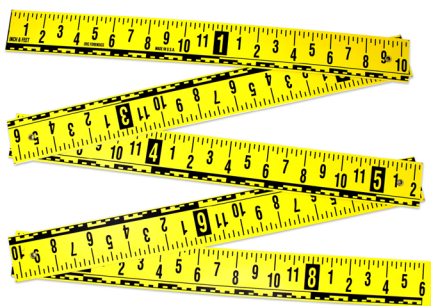

Not actual size

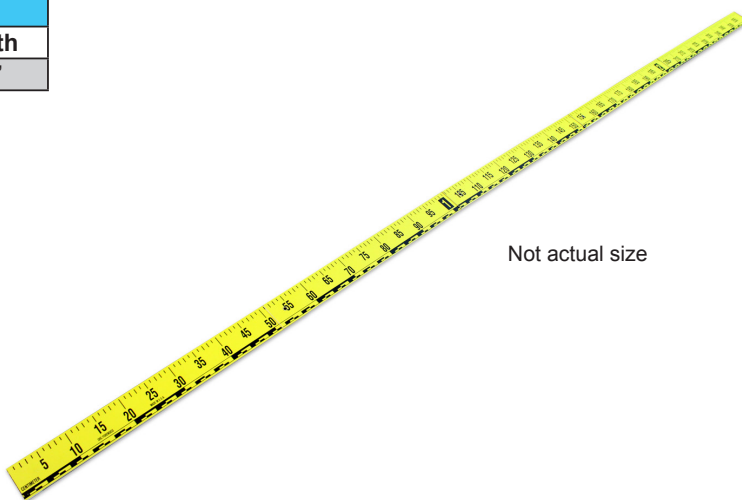

Not actual size

82" or 208cm, Left to Right

Two-Sided Fractional & Metric		
Part #	Material	Length
4LFMR-YW082L-4PC	Plastic	82"

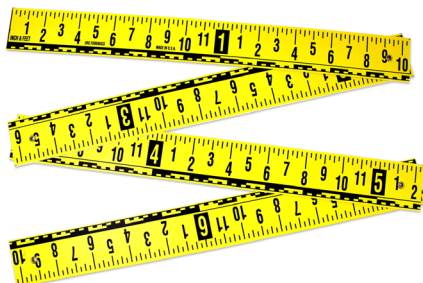

Not actual size

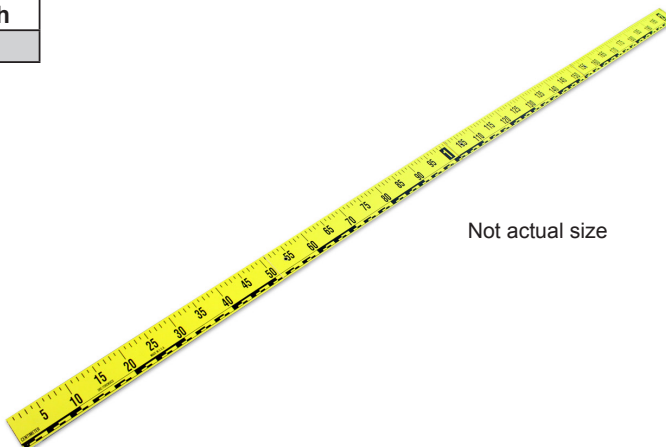

Not actual size



ORC Forensics' Footprint and Tire Track Frame of References are rulers and corner squares purposely designed to compliment the FBI's Bureau Scales. The original Bureau Scale is a specific corner square based on FBI guidelines and recommendations. These items are used as official equipment for their photographers at crime scenes. Use the Footprint and Tire Track Frame of References as measurement guides when taking photographs out in the field, the black-and-white graphics are calculated to give the user clarity and great readability from a distance.

Fixed Angle Plastic Corner Squares

Fixed Angle

Side 1

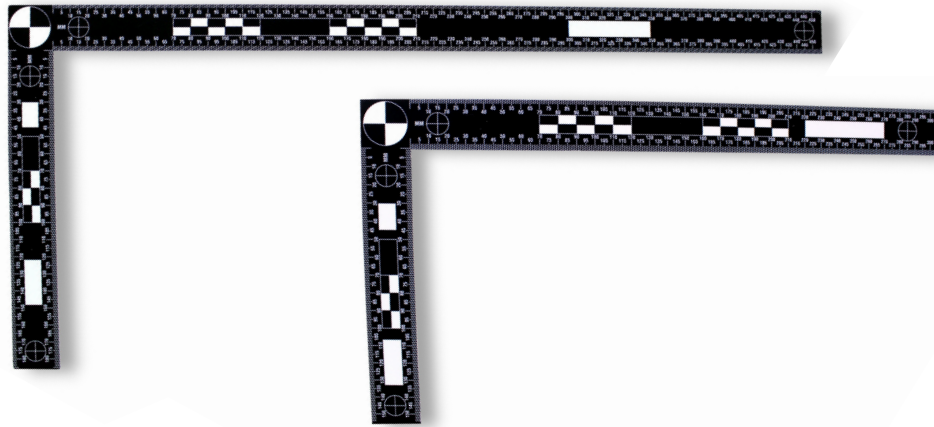

Not actual size

Side 2

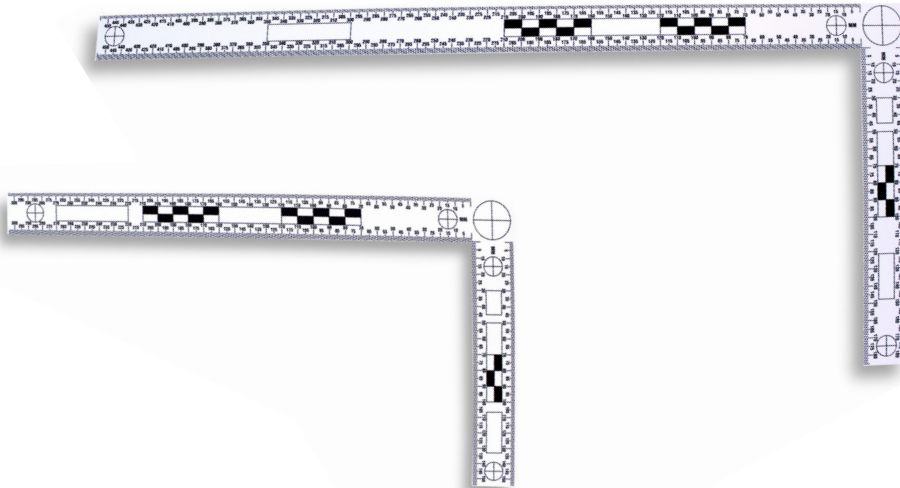

Not actual size

Two-Sided Metric		
Part #	Material	Length
4CSM-BW15x30D-PL	Plastic	15cm x 30cm
4CSM-BW18x45D-PL	Plastic	18cm x 45cm

These Corner Squares are the tools often used for measuring foot and hand prints at crime scenes. The 15cm x 30cm model holds the distinction of being the original Bureau Scale designed for the FBI several decades ago. Many of the features on the rule are similar to our other Footprint and Tire Track Frame of References, including the .06 tk plastic it is made from. **Each of these Larger Corner Squares is double sided with inverse colors on the opposite sides.** Black Background/White Graphics & White Background/Black Graphics is the standard color option. Each of the Dual Edge Fixed Angle Corner Squares ordered comes with a ruler matching the graphics and length of the smaller side.



Another feature of our Angled Plastic Corner Squares are the Parralox Circles. The Parralox Circle, located on the corner of each Corner Square, is a useful tool for analyzing and referencing photographs. An investigator can review the shape and displacement of the circle graphic in order to determine if the picture was taken at an angle, or if there is a change of depth. This would be difficult to accomplish using rulers without the Parralox circles. These circles reinforce our commitment to making measurement devices that achieve the highest level of accuracy and functionality.

Folding Angle Plastic Corner Squares

Folding Angle



Not actual size

Two-Sided Metric		
Part #	Material	Length
4CSM-BW15x30D-PL/FA	Plastic	15cm x 30cm



Not actual size

Two-Sided Metric		
Part #	Material	Length
4CSM-BW18x45D-PL/FA	Plastic	18cm x 45cm



Folding Angle Plastic Corner Squares (Continued)



Not actual size

Not actual size

Folding Angle

Two-Sided Metric		
Part #	Material	Length
4CSM-BW22x45D-PL/2FA	Plastic	22cm x 45cm

Large Graduated Angles and Rules

The Fractional 2-Sided Folding Angle and Ruler measuring tools are designed to serve multiple frame-of-reference applications, and are **designed with a different reading style on each side**. On one side, the bottom piece of this folding ruler will be turned 90° to create an x- and y-axis and become a measuring angle, or corner square, and when you flip it to the other side, the three pieces line up to create a long vertical up reading ruler, which starts with a true zero edge.

Fractional 2-Sided Folding Angle and Rule

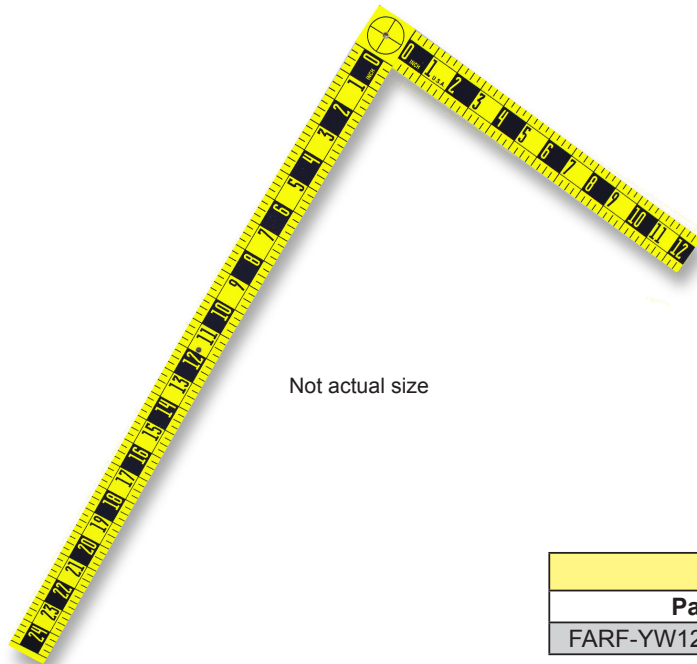

These Large Graduated Folding Angles and Rules are constructed of a semi-rigid plastic approximately 1/16" thick. The 3-Piece units are hinged to fold at every foot of length, and the hinges are built tight enough so that they keep the shape they are positioned into.

Each section of these rules are 1 1/2" wide and designed with large enough numbers to be seen from far away. The black graphics on a yellow background are used to create contrast for optimum viewing in both photographs and in the field.

Large Graduated

Two-Sided Fractional		
Part #	Material	Length
FARF-YW12x25+38-3PC	Plastic	12" x 25" or 38"

Metric 2-Sided Folding Angle and Rule

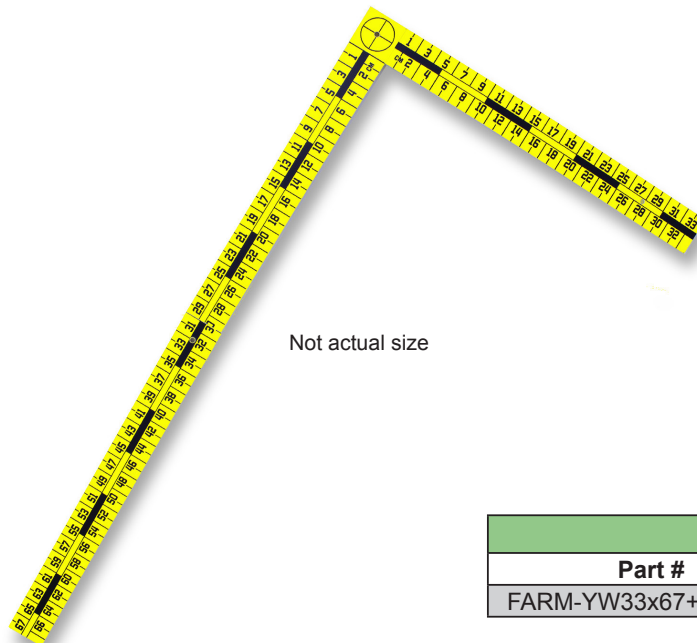
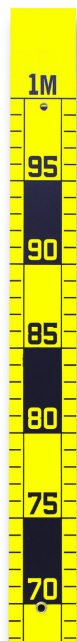

These tools are incredibly durable and portable. Units are constructed with folding angles joined together with 3/16" diameter brass eyelets and fold down into a smaller shape: approximately 1 1/2" wide x 3/16" thick x 15" long.

The Large Graduated Folding Angles and Rules are rustproof and waterproof. Each rule is top coated for a true non-glare photographic surface, which also adds extra chemical protection.

Two-Sided Metric		
Part #	Material	Length
FARM-YW33x67+100-3PC	Plastic	37cm x 67cm or 100cm



Fractional 2-Sided Ruler - 12" Left to Right or 12" Vertical



Fractional		
Part #	Material	Length
FARF-YW012L/VU	Plastic	12"

The Large 2-Sided Fractional Ruler measuring tool is intended to serve multiple applications, and designed with a **different reading style on each side**.

One side is 12" left to right, and the other side is 12" vertical up. Both sides start with a true zero edge. This rule is designed to work beside the large 2-Sided Folding Rules on the previous page.

This rule is constructed of a semi-rigid plastic approximately 1/16" thick, 1 1/2" wide; and it is designed with large numbers to be seen from a distance. The black graphics on a yellow background are used to create contrast for optimum viewing in both photographs and use in the field.

Side 2



Not actual size

Large Graduated

Metric 2-Sided Ruler - 30cm Left to Right or 30cm Vertical

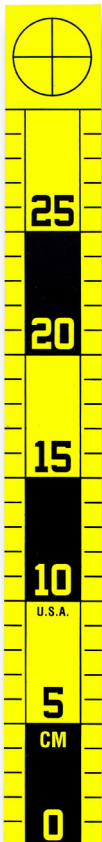

Metric		
Part #	Material	Length
FARM-YW030L/VU	Plastic	30cm

One side is a 30cm left to right ruler, and the other side is 30cm vertical up. Both sides start with a true zero edge. This rule is designed to complement the large 2-Sided Folding Rulers on the previous page.

This rule is incredibly durable and portable. The Large 2-Sided Rulers are rustproof and waterproof, and each of these rules is top coated for a true non-glare photographic surface, which also adds extra chemical protection.

Side 2

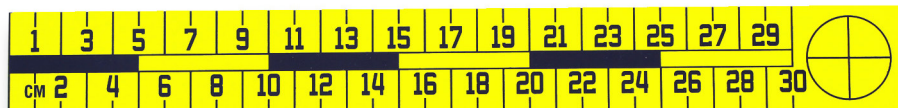

Not actual size

Large Ruler Rolls

MPF Stringer Rule - Fractional - 8 Feet Long

Fractional		
Part #	Color	Length
MPFSF-WH096	White/Black	8 feet

The MegaPictoFramus™ (MPF) Stringer rule reinvents the common roll tape into a large-scale frame of reference for forensic and medical photography. Ideally, this could also become an essential tool for a wide range of industries: Arson Investigation, Horticulture, Mineralogy, Paleontology, Archeology, Civil Engineering, Anthropology, Criminology, Geology, and Zoology.

While rolled up compactly, any MPF Stringer Rule can easily fit into a shirt pocket. Unfurl it to reveal an impressive flat weatherproof ruler. Each end is anchored with easy grip handles. Each MPF Stringer Rule is printed with our Optirectilinear® graphics, which are markings that allow measurements to be easily read from long distances, up to 40 feet away. The black printing on a white background provide the optimum contrast for any photo.

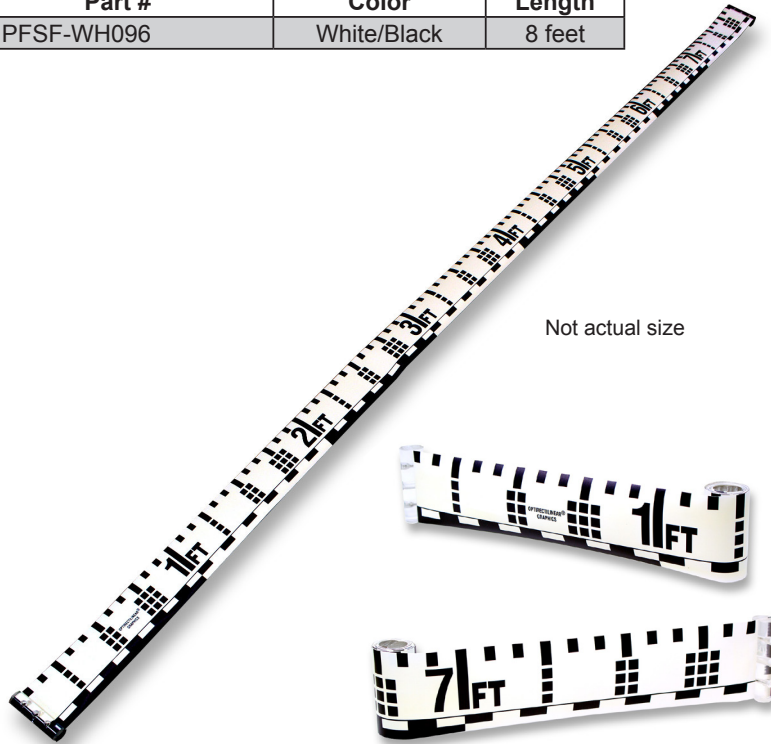

Not actual size

Large Ruler Rolls

MPF Stringer Rule - Metric - 2.5 Meters Long

Metric		
Part #	Color	Length
MPFSM-WH250	White/Black	2.5 m

The MPF Stringer Rule is made of a tough, stretch-resistant, vinyl fiber that allows the unit to keep its form and provide accurate measurements no matter how much it is used. These materials also allow the unit to be waterproof and easily cleaned. Grips are made of an impact-resistant plastic with stainless steel screws. MPF Stringer Rules are each 3 1/4" wide. These are available in either Fractional or Metric measurement reading style.

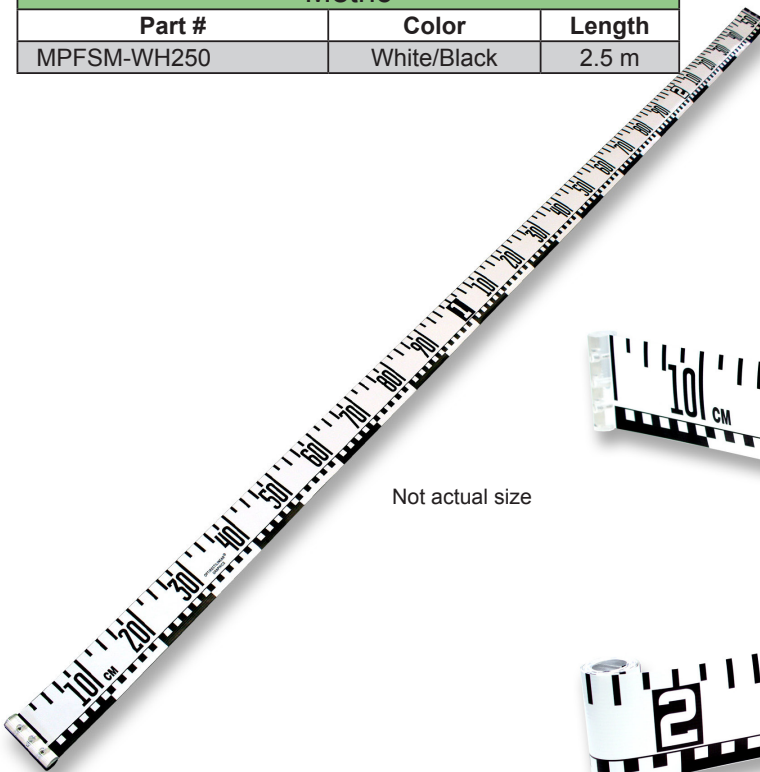

Not actual size



ORC Forensics has created a practical set of adhesive identification labels, which include a 2cm ruler on the bottom edge for easy frame of reference. **The decals are 1" wide by 1-1/2" tall overall**, and each sheet has 50 labels (one letter represented per sheet, so A to Z is 26 sheets). These labels help crime scene investigators organize and label potential pieces of evidence all around an incident's location.

Each decal in the Alphabet, Number, and Arrow Icon Set is a bold, yellow, and darkly outlined icon, plus the 2cm ruler on the bottom. The Blank Icon Set features a grid. The icons themselves measure 3/4" x 3/4". **At the base of each one is a 2cm rule featuring our Optirectilinear® graphics for distance reading.** They are produced with a non-glare surface, which is beneficial to photographing the labels. The adhesive backing is high tack, but designed to be removable without causing surface degradation or leave a residue. Safely apply these to walls, skin, glass, painted surfaces, hair, rugs, or plastics, nearly anything. You can reuse labels several times until the adhesive surface degrades.

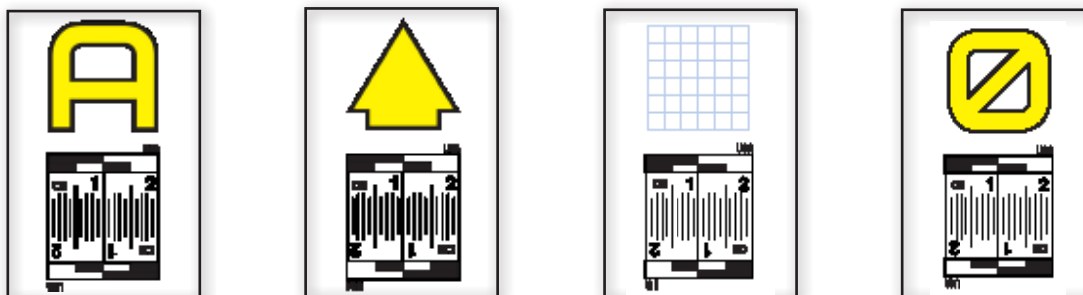

I.D. Labels

Double-Edged Metric			
Part #	Type	Sheets	Length
4MANDY-AS	Letters Set (A-Z)	26	2cm
4MANDY-UA	Up Arrows Set	10	2cm
4MANDY-BK	Blank Set	10	2cm
4MANDY-NS	Numbers Set (0-9)	10	2cm

For complete sets previews, visit our website at:
https://oregonrule.com/product-category/forensics/forensics-id_labels/



Adhesive Ruler Decals

ORC Forensics delivers a versatile line of inexpensive, adhesive rulers. These come pre-wound on a roll, and provides writing space for identification and reference. Our Adhesive Ruler Decals can be used by forensic practitioners, medical examiners, arson investigators, and much more. Each of these decals are individualized on a paper liner, and economically spaced together. Place these near a point of interest and they act as both a frame of reference and a label. Photograph things like blood splatters, fingerprints, and bullet casings with one of these labels in the frame to get excellent reference points.

Adhesive Ruler Decals come in many varieties, including length, color, and quantity. **All units feature a non-glare surface and come with an adhesive backing that is high-tack, but removable, and will not cause surface degradation or leave a residue.** Safely apply these to skin, glass, painted surfaces, hair, rugs, plastics, or nearly anything.

All of our Adhesive Ruler Decals use Optirectilinear® graphics represented by the black and white rectangular pattern. This pattern enhances visibility from a distance, and is distinguishable in photographs. Peel and stick these Adhesive Ruler Decals near anything you want to draw attention to, or document.

12 inches / 30cm Long - 50 Rulers per Roll

Double-Edged Fractional & Metric

Part #	Color	Length
4RFM-WH012x50R	White	12" / 30cm

Adhesive Ruler Decals



Not actual size



4 inch / 10cm Long -200 Rulers per Roll

Double-Edged Fractional & Metric		
Part #	Color	Length
4RFM-BK004x200R	Black	4" / 10cm

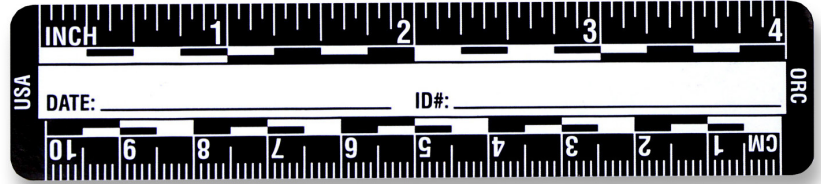

4 inch / 10cm Long -200 Rulers per Roll

Double-Edged Fractional & Metric		
Part #	Color	Length
4RFM-WH004x200R	White	4" / 10cm

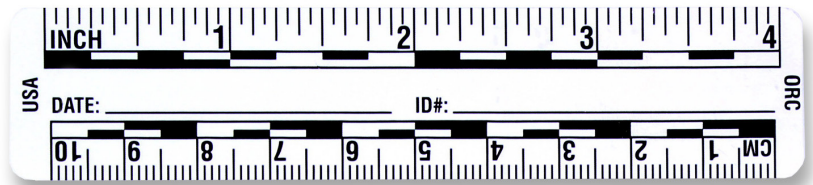

Adhesive Rules

4 inch / 10cm Long -200 Rulers per Roll

Double-Edged Fractional & Metric		
Part #	Color	Length
4RFM-GY004x200R	Gray	4" / 10cm

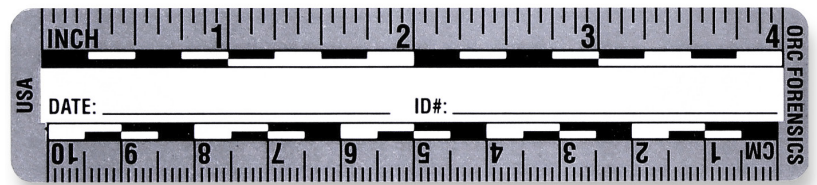



2 inch / 5cm Long -200 Rulers per Roll

Double-Edged Fractional & Metric		
Part #	Color	Length
4RFM-FGR002x200R	Fluorescent Green	2" / 5cm

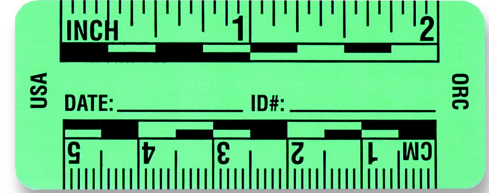

2 inch / 5cm Long -200 Rulers per Roll

Double-Edged Fractional & Metric		
Part #	Color	Length
4RFM-FOG002x200R	Fluorescent Orange	2" / 5cm

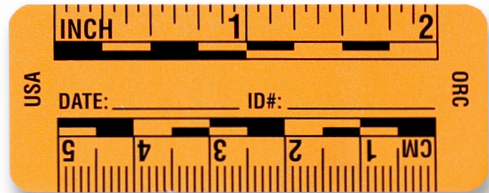

2 inch / 5cm Long -200 Rulers per Roll

Double-Edged Fractional & Metric		
Part #	Color	Length
4RFM-FYW002x200R	Fluorescent Orange	2" / 5cm

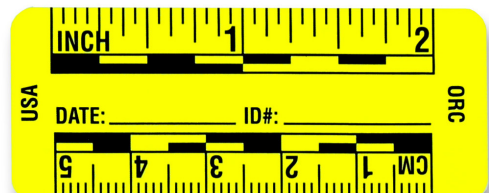

Adhesive Rules



2 inch / 5cm Long -200 Rulers per Roll

Double-Edged Fractional & Metric		
Part #	Color	Length
4RFM-BK002x200R	Black	2" / 5cm



2 inch / 5cm Long -200 Rulers per Roll

Double-Edged Fractional & Metric		
Part #	Color	Length
4RFM-WH002x200R	White	2" / 5cm

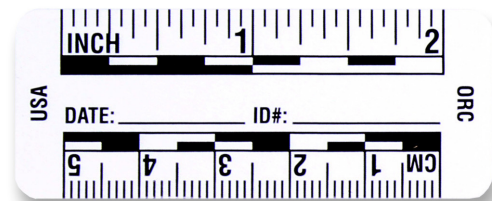

Adhesive Rules

2 inch / 5cm Long -200 Rulers per Roll

Double-Edged Fractional & Metric		
Part #	Color	Length
4RFM-GY002x200R	Gray	2" / 5cm

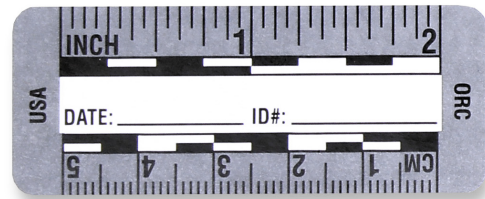



2 cm Long -250 Rulers per Roll

Double-Edged Fractional & Metric		
Part #	Color	Length
CN-B/W0.02Lx250R	Black/White	2cm

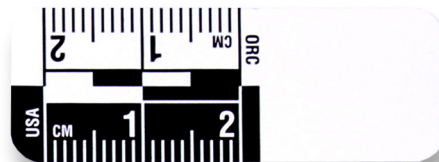

Not actual size

2 cm Long -250 Rulers per Roll

Double-Edged Fractional & Metric		
Part #	Color	Length
CN-W0.02Lx250R	Black/White	2cm

Adhesive Rules

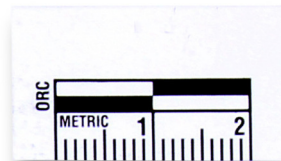

Not actual size



The Adhesive Corner Square Decals from Oregon Rule Co.'s Forensics Products are standard equipment for any crime scene detective. The below Adhesive Corner Square Decals are inexpensive, single use adhesive labels that feature a corner square to give your image an instant frame-of-reference. Commonly, an investigator will stick these over an area that has blood splatter or bullet holes. Pictures that include Adhesive Corner Square Decals have a perfect dimensional record to be analyzed later. At Oregon Rule Co., we are constantly overwhelmed with phone and email inquiries from people that see these labels on their local news reports and ask how to get them.

Purchasing a roll of Adhesive Corner Square Decals gives you 100 labels that can be used in a variety of ways. **We have three sizes available, 3" wide (metric only) and 1 7/8" wide (fractional and metric).** Each of the individual labels has open white spaces and lines to be used for labeling. All units feature a non-glare surface and come with an adhesive backing that is high-tack, but removable, and will not cause surface degradation or leave a surface residue. Safely apply these to skin, glass, painted surfaces, hair, rugs, or plastics, nearly anything.

3/4" x 3/4" – Roll with 100 Repeats

Two-Sided Fractional & Metric		
Part #	Color	Length
FCS-W.75x.75x100R	White/Black	3/4" x 3/4"

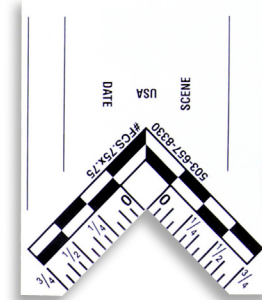

Not actual size

2cm x 2cm – Roll with 100 Repeats

Two-Sided Fractional & Metric		
Part #	Color	Length
MCS-W2x2x100R	White/Black	2cm x 2cm

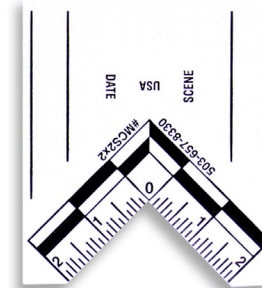

Not actual size

Adhesive
Corner
Squares

4cm x 4cm – Roll with 100 Repeats

Two-Sided Fractional & Metric		
Part #	Color	Length
MCS-W4x4x100R	White/Black	4cm x 4cm

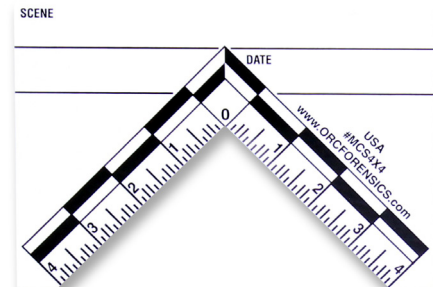

Not actual size

Oregon Rule Co. has another option for adhesive rules, Continuous Roll Tapes. All Continuous Roll Tapes are economical, convenient, and come on a self-wound roll, no liner required. **Instead of individualized decals, these tapes are all one long piece that has ruler graduation graphics repeating either every foot, yard, or meter.** Rip or cut these rules to your desired length, and stick them on nearly anything. The adhesive is made similar to "Painters Mask" quality; safely applies to surfaces without fear of residue or surface degradation. The material is paper that is coated to minimize liquid absorption and UV fading.

There are several advantages the Oregon Rule Co. Continuous Roll Tapes have over other similar products. At the Zero Line, which is the beginning of each repeat, the tape includes an open box so that you may write in a reference number. This is handy so that you can easily take a 12" repeating tape and mark it so that it is a tape that reads several feet, rip it off, and then start back at zero for the next section. Also, each of these **Continuous Roll Tapes read with a dual edge so that they are both left-to-right and right-to-left reading rules.**

1.5" Wide X 12" Long Ruler - 100 Repeats

Double-Edged Fractional		
Part #	Color	Length
1 1/2FERT-YW012VUx105R	Yellow	12"

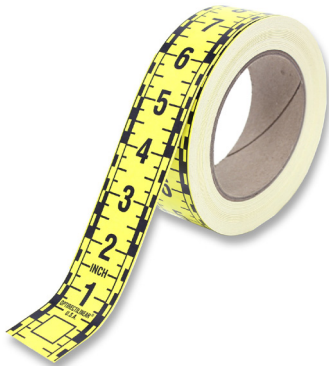

Not actual size

1" Wide X 12" Long Ruler - 42 Repeats

Double-Edged Fractional		
Part #	Color	Length
FERT-W12Dx42R	White	12"



Not actual size



3/4" Wide X 36" Long Ruler - 35 Repeats

Double-Edged Fractional		
Part #	Color	Length
FERT-Y36Dx35R	Yellow	36"

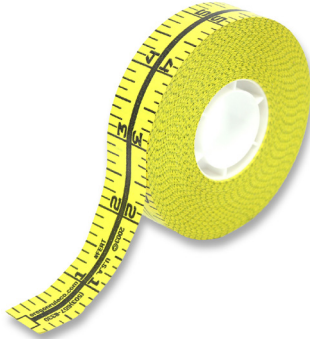

3/4" Wide X 1 Meter Long Ruler - 32 Repeats

Double-Edged Metric		
Part #	Color	Length
MERT-W1.0DX32R	White	1m

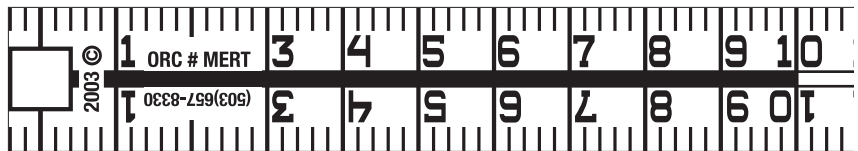

Roll
Tapes

Adhesive Evidence Decals - 100 Repeats

Adhesive Decal		
Part #	Color	Length
4EVID-R1.0x100R	White/Red	



Oregon Rule Co. Forensics Products has tweaked the design of the classic Clear Semi Circle Protractor and turned it into a professional-grade equipment for any crime scene investigator. **Being clear (see-through), investigators may overlay the tool on points of interest to get an angle measurement without visual obstruction.** Two highlighted feature uses for these protractors are: measuring blood spatters, and measuring ballistic trajectories. In the medical field, professionals use our protractors to measure on top of x-rays and photographs.

Clear Semi Circle Protractor

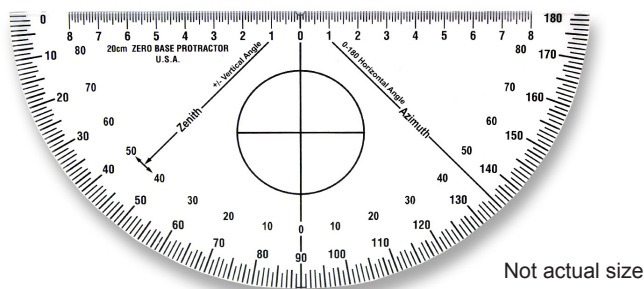

Not actual size

180 Degrees Counter Clockwise

Part #	Material	Length x Width
8GDS-CL180CCW+CN08HC	Plastic	20cm x 10cm

This protractor, officially called the 8" Graduated Dial Segment, is a forensic tool that has become very popular in a short amount of time. Some of the sought after features include: **.065" thick clear plastic** with black graphics; a compact **20cm wide and 10cm tall** overall design; **180 degrees** of measurement reading **counter clockwise**; and a narrow **horizontally centered scale** at the base reading **8cm in each direction**.

Customizations like private labeling and graphic colors are available. Please contact a sales associate via phone or email for more information.

Mr. T Squares

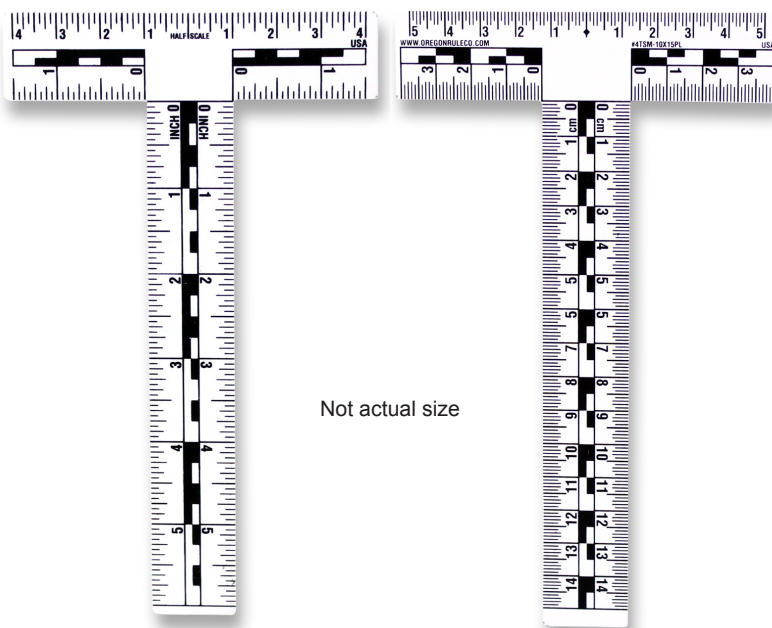

Not actual size

Fractional

Part #	Color	Width x Length
4TSF-WH4x6D/5PK	White	4" x 6"
4TSF-CL4x6D/5PK	Clear	4" x 6"

Metric

Part #	Color	Width x Length
4TSM-WH10x15D/5PK	White	10cm x 15cm
4TSM-CL10x15D/5PK	Clear	10cm x 15cm

Oregon Rule Co. Forensics Products designed the Mr. T-Square™, a pocket sized T-Square intended to provide a quick frame of reference, for pictures or drawing and drafting. Two different material options are available. White plastic and clear (see-through) plastic, each approximately 0.03" thick. Further, we offer these materials with graphics measuring fractional (inches with 1/16" graduations) and metric (centimeters with 1mm graduations). **The dimensions of the Mr. T-Square™ are 4" x 6" or 10cm x 15cm.**

The designs on these tools include our Optirectilinear® graphics, which are the black rectangles you see on many of our products. These patterns help read measurements from a greater distance and provide greater clarity of major increments when analyzing photographs.

When you use multiple Mr. T-Squares™ you can combine them to create other simple tools such as slide calipers or 6" x 6" corner squares.

Customizations like private labeling, custom graphics, half scales, and graphic colors are available. Please contact an Oregon Rule Co. sales associate for more details.



Oregon Rule Co. Forensics Products' Eye-Dentify™ Cards are wallet sized reference cards for measuring dilated pupils. The 17 dots on the face of each card offer a range from 2.0mm to 10.0mm in 0.5mm increments. The design of these cards place each measurement dot on the outside edge to easily compare the eye in question.

Eye-Dentify Cards are sold in 5-Packs, one-sided, and laminated for durability. Each card measures approximately 2 1/4" x 3 3/4", which can easily fit in a wallet, glove compartment, or tool kit.

Customizations and quantity discounts are available; please contact an Oregon Rule Co. sales associate for more details.

Eye Pupil Size Cards

Pupil Diameter Reference - 5 Pack		
Part #	Material	Length x Width
4PDRM-10/5PK	Laminated	2 1/4" x 3 3/4"

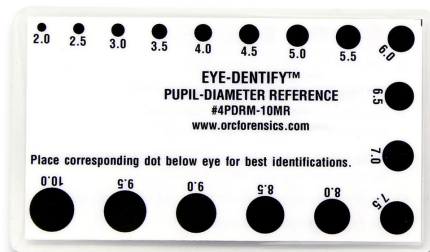

Not actual size

Superficial Trauma Discoloration Card - Light Skin Tone



Not actual size

Discoloration Card - 5 Pack		
Part #	Material	Length x Width
STD3550/5PK	Laminated	2 1/4" x 3 3/4"

Oregon Rule Co. Forensics Products' Superficial Trauma Discoloration Cards (Bruise Color Cards) are handy guides that associate a number identity to various bruise colors for forensics and medical practices.

The units are laminated and credit card sized, about 2 1/4" x 3 3/4", so that they can easily be carried around in your pocket or be a practical fit in a tool kit.

This tool is used to analyze bruise color changes over time. It can be difficult to use adjectives to describe color, so our Superficial Trauma Discoloration Card intends to eliminate having to interpret multiple descriptions of bruise colors. Each Superficial Trauma Discoloration Card provides exact language and labels for specific bruise colors, so that a standard definition can be shared between people or departments.

Superficial Trauma Discoloration Card - Dark Skin Tone



Not actual size

Discoloration Card - 5 Pack		
Part #	Material	Length x Width
STD0520/5PK	Laminated	2 1/4" x 3 3/4"

There are two card options to choose from, and they are each packaged in sets of 5. The two card options are for either light skin tone or dark skin tones. Each card is double-sided with 24 colors on each side, making **48 unique colors per card**. The cards are used as a frame of reference to identify the human skin bruise color at a definite time. "Dark red" could mean a different color to several people, whereas a "light skin tone #24" is a straight-forward, easily referenced label.

For consistency, we have a specific recommendation for recording each number/color. We suggest recording each color number along with the basic PCN printed on the card.

For example, color number "19" could be recorded as: #STD0520-070201-19. This gives you a traceable number back to Oregon Rule Co's Forensics Standard Color Matched Certification System, which is a specifically designed for bruise color selection. If a camera is available, we suggest taking pictures with both the bruise and the card in frame to provide conclusive evidence.

Cards and Charts



Like our Superficial Trauma Discoloration Cards, these larger Bruise Color Charts are unique and distinctive tools for identifying bruise colors on human skin. **These charts measure approximately 6 1/8" x 3 7/8" and are made of sturdy 0.03" inch thick plastic.**

Large Bruise Color Charts – Dark Skin Tone

Bruise Color Chart - 5 Pack		
Part #	Material	Length x Width
BCC3550/5PK	Plastic	6 1/8" x 3 7/8"



Not actual size

5 pack

Large Bruise Color Charts – Light Skin Tone

Bruise Color Chart - 5 Pack		
Part #	Material	Length
BCC0520/5PK	Plastic	6 1/8" x 3 7/8"



Not actual size

5 pack

Cards and Charts

**Rules**

2 inch / 5 centimeter - Black	Fractional	1
2 inch / 5 centimeter - Blue	Fractional	1
2 inch / 5 centimeter - Gray	Fractional	1
2 inch / 5 centimeter - White	Fractional	1
2 inch / 5 centimeter - Yellow	Fractional	1
4 inch / 10 centimeter - Black	Metric	2
4 inch / 10 centimeter - Blue	Metric	2
4 inch / 10 centimeter - Gray	Metric	2
4 inch / 10 centimeter - White	Metric	2
4 inch / 10 centimeter - Yellow	Metric	3
4 inch / 10 centimeter - Clear	Metric	3

Corner Squares

3 inch x 3 inch - Black	Fractional	4
3 inch x 3 inch - White	Fractional	4
3 inch x 3 inch - Blue	Fractional	4
3 inch x 3 inch - Gray	Fractional	4
3 inch x 3 inch - Clear	Fractional	5
3 inch x 3 inch - Yellow	Fractional	5
8 cm x 8cm - Black	Metric	5
8 cm x 8cm - White	Metric	5
8 cm x 8cm - Blue	Metric	6
8 cm x 8cm - Gray	Metric	6
8 cm x 8cm - White	Metric	6
8 cm x 8cm - Yellow	Metric	6
5 cm x 5cm - ABFO	Metric	6

Extra Long Folding Rules

102" or 260cm, Left to Right	Fractional & Metric	7
82" or 208cm, Left to Right	Fractional & Metric	7

Footprint and Tire Tracks

15cm x 30cm Fixed Angle Plastic Corner Square	Metric	8
18cm x 45cm Fixed Angle Plastic Corner Square	Metric	8
15cm x 30cm Folding Angle Plastic Corner Square	Metric	9
18cm x 45cm Folding Angle Plastic Corner Square	Metric	9
22cm x 45cm Folding Angle Plastic Corner Square	Metric	10

Large Graduated Angles and Rules

Fractional 2-Sided Folding Angle and Ruler	Fractional	11
Metric 2-Sided Folding Angle and Ruler	Metric	11
Fractional 2-Sided Ruler	Fractional	12
Metric 2-Sided Ruler	Metric	12



Long Ruler Rolls

8 Foot Long MPF Stringer Rule	Fractional	13
2.5 Meters Long MPF String Rule	Metric	13

I.D. Labels

Alphabet Set (A to Z) - 26 Sheets of Labels	Metric	14
Up Arrow Set - 10 Sheets of Labels	Metric	14
Blank Icon Set - 10 Sheets of Labels	Metric	14
Number Set (0-9) - 10 Sheets of Labels	Metric	14

Adhesive Rules

12 inches / 30cm Long - 50 Rulers per Roll	Fractional & Metric	15
4 inch / 10cm Long -200 Rulers per Roll	Fractional & Metric	16
4 inch / 10cm Long -200 Rulers per Roll	Fractional & Metric	16
4 inch / 10cm Long -200 Rulers per Roll	Fractional & Metric	16
2 inch / 5cm Long -200 Rulers per Roll	Fractional & Metric	17
2 inch / 5cm Long -200 Rulers per Roll	Fractional & Metric	17
2 inch / 5cm Long -200 Rulers per Roll	Fractional & Metric	17
2 inch / 5cm Long -200 Rulers per Roll	Fractional & Metric	18
2 inch / 5cm Long -200 Rulers per Roll	Fractional & Metric	18
2 inch / 5cm Long -200 Rulers per Roll	Fractional & Metric	18
2 cm Long - 250 Rulers per Roll	Metric	19
2 cm Long - 250 Rulers per Roll	Metric	19

Adhesive Corner Squares

2cm x 2cm – Roll with 100 Repeats	Metric	20
3/4" x 3/4" – Roll with 100 Repeats	Metric	20
4cm x 4cm – Roll with 100 Repeats	Metric	20

Roll Tapes

1.5" Wide X 12" Long Ruler - 100 Repeats	Fractional	21
1" Wide X 12" Long Ruler - 42 Repeats	Fractional	21
Adhesive Evidence Decals - 100 Repeats	N/A	22
3/4" Wide X 1 Meter Long Ruler - 32 Repeats	Metric	22
3/4" Wide X 36" Long Ruler - 35 Repeats	Fractional	22

Hand Tools

Clear Semi Circle Protractor	Degrees	20
Mr. T Square - White or Clear	Fractional or Metric	20

**Staff Gauges**

Eye Pupil Size Chart		24
Superficial Trauma Discoloration Card - Light Skin Tone		24
Superficial Trauma Discoloration Card - Dark Skin Tone		24
Large Bruise Color Charts – Dark Skin Tone		25
Large Bruise Color Charts – Light Skin Tone		25



P.O. BOX 1752, OREGON CITY, OR 97045
PH: (503) 657-8330 • FAX 655-8040
Web Site: www.oregonrule.com
E-mail: sales@oregonrule.com